

INSTALLATION

WELD IN
• BOLT IN
STANDARD CLAMP IN
CONCEALED CLAMP IN

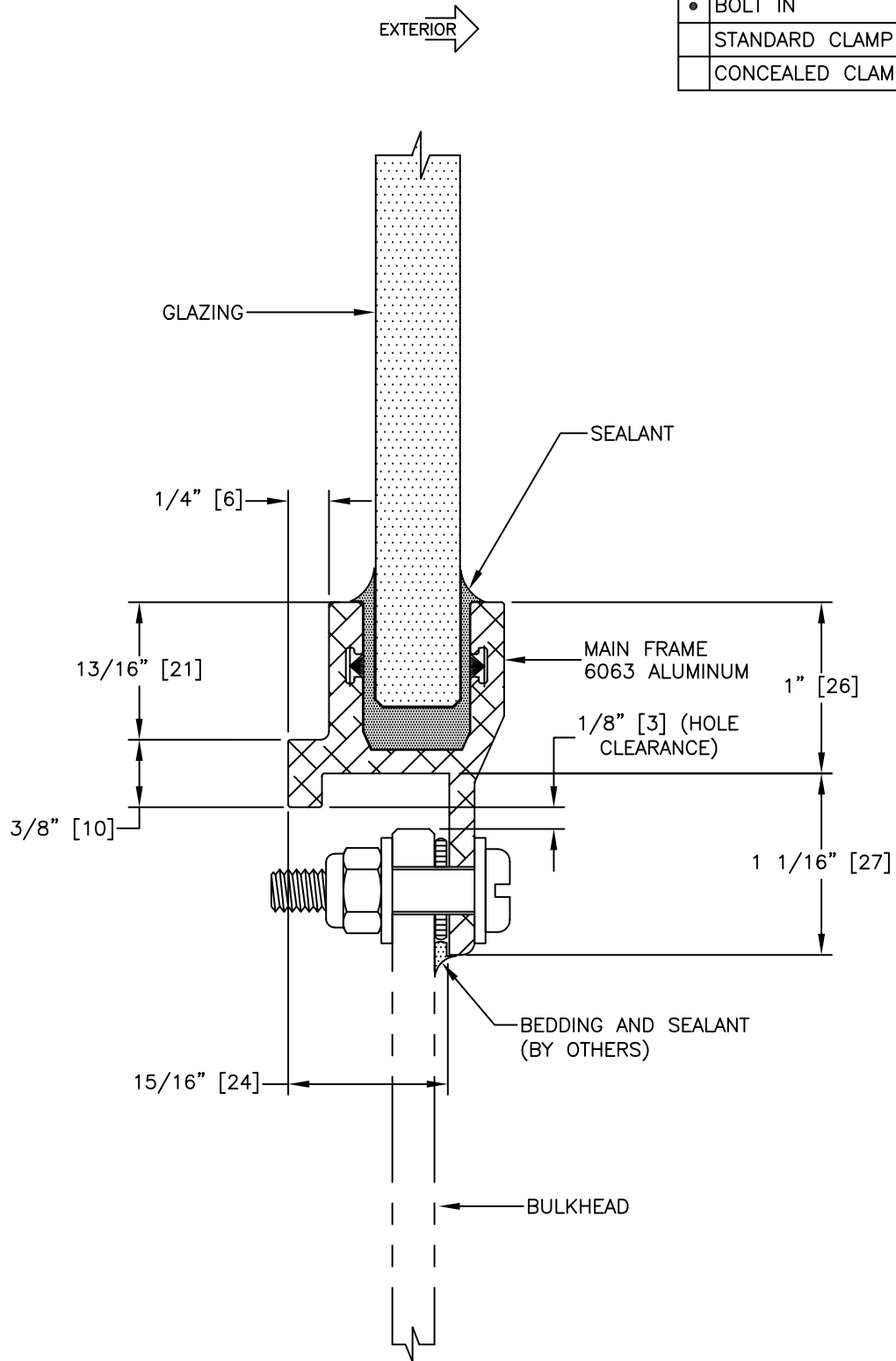

STANDARD PLATE CUT RADIUS IS 3 1/8" [79] AND 3 5/8" [92].
 GLAZING THICKNESS TO BE 1/2" [13mm].



TITLE: FIXED WINDOW

MODEL NO. PCM-1086-FX

REV
—

SCALE: FULL SIZE SHEET: 1 OF: 1