

INSTALLATION

WELD IN
• BOLT IN
• STANDARD CLAMP IN
• CONCEALED CLAMP IN

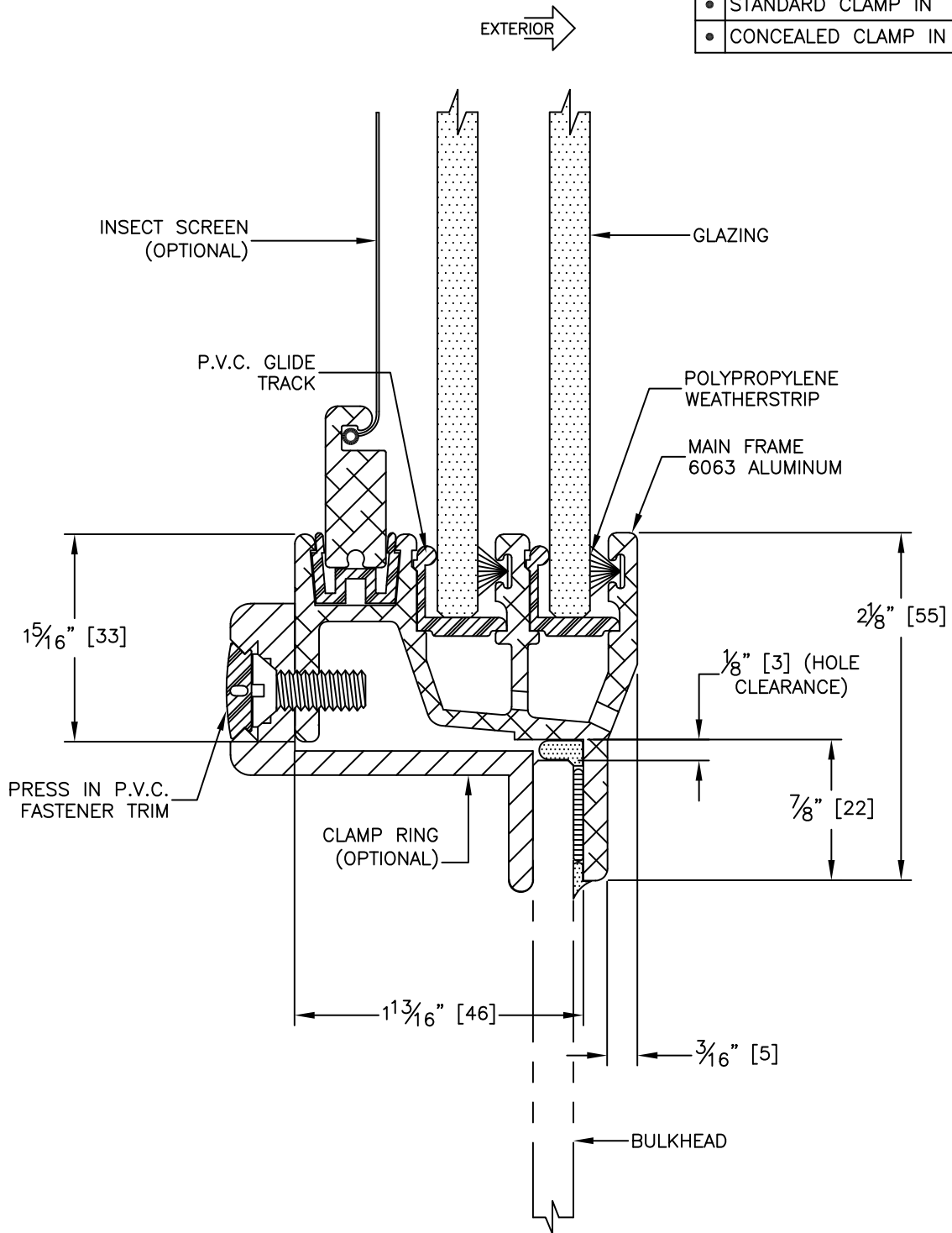

GLAZING THICKNESS TO BE 1/4" [6mm].
 STANDARD PLATE CUT RADIUS IS 3 1/8" [79mm], 3 5/8" [92mm], AND 4 1/8" [105mm].



TITLE:
 HORIZONTAL SLIDING WINDOW

MODEL NO.
 PCM-1066-HS

SCALE: FULL SIZE SHEET: 1 OF: 1

REV
 —